



# Digital Cordless Keyphone DECT-8000

## USER'S MANUAL



## Table of Contents

---

Checking Parts .....	3
Control Locations .....	4
LCD Window Icon Descriptions .....	6
Connecting Power Adapter .....	7
Installing Batteries .....	8
Charging the Handset .....	10
Using the Handset Carrying Clip .....	11
Using the Ear-microphone (option) .....	12
Turning the Handset On/Off .....	13
Registering Handset .....	14
Your Phone's Mode .....	16

### Basic Functions

Making a Call .....	17
Receiving a Call .....	19
Out of Range Indication .....	20
Battery Level Indicator .....	20
Adjusting Voice Volume .....	21
Selecting Ring Type .....	21
Adjusting Ring Volume .....	22
Last Number Redial .....	23
Fuzzy Dialing .....	24
Putting a Call on Hold .....	25
Transferring a Call .....	26
Setting Up a Conference .....	27
Key Lock .....	28
Registered Recall .....	29

### Menus

Menu Navigation .....	30
Menu Map .....	32

### Call Log

Call Log .....	33
----------------	----

## Phonebook

Storing a Phone Number with a Name .....	36
Using a Pause .....	39
Dialing a Number in Phonebook .....	40
Searching for Numbers in Phonebook .....	41
Erasing Numbers from the Phonebook .....	42
Changing Your Internal Phonebook .....	43

## Setting

Setting Handset Name .....	44
Selecting Language .....	45
Setting Call Time Display .....	46
Editing Prefix Number .....	47

## Bell & Beep

Setting Key Tone .....	48
Selecting Ring or Vibrator .....	49
Setting Unique Ring .....	50

## System

Changing PIN .....	51
Reset .....	52

## Additional Features

Selecting Base .....	53
Do Not Disturb .....	54

Troubleshooting .....	55
Specifications .....	57

## Checking Parts

Once you have unpacked your phone, check to make sure that you have all the parts shown below. If any piece is missing or broken, please call your dealer.



**Handset**

(with Belt clip attached)

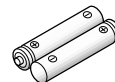

**Two AA Batteries**

(Rechargeable Ni-MH batteries)

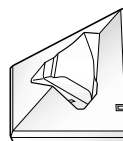

**Charger**



**User's Manual**

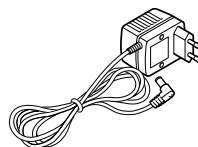

**Power adapter**

### Option

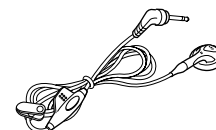

**Ear-microphone**

# Control Locations

## Handset

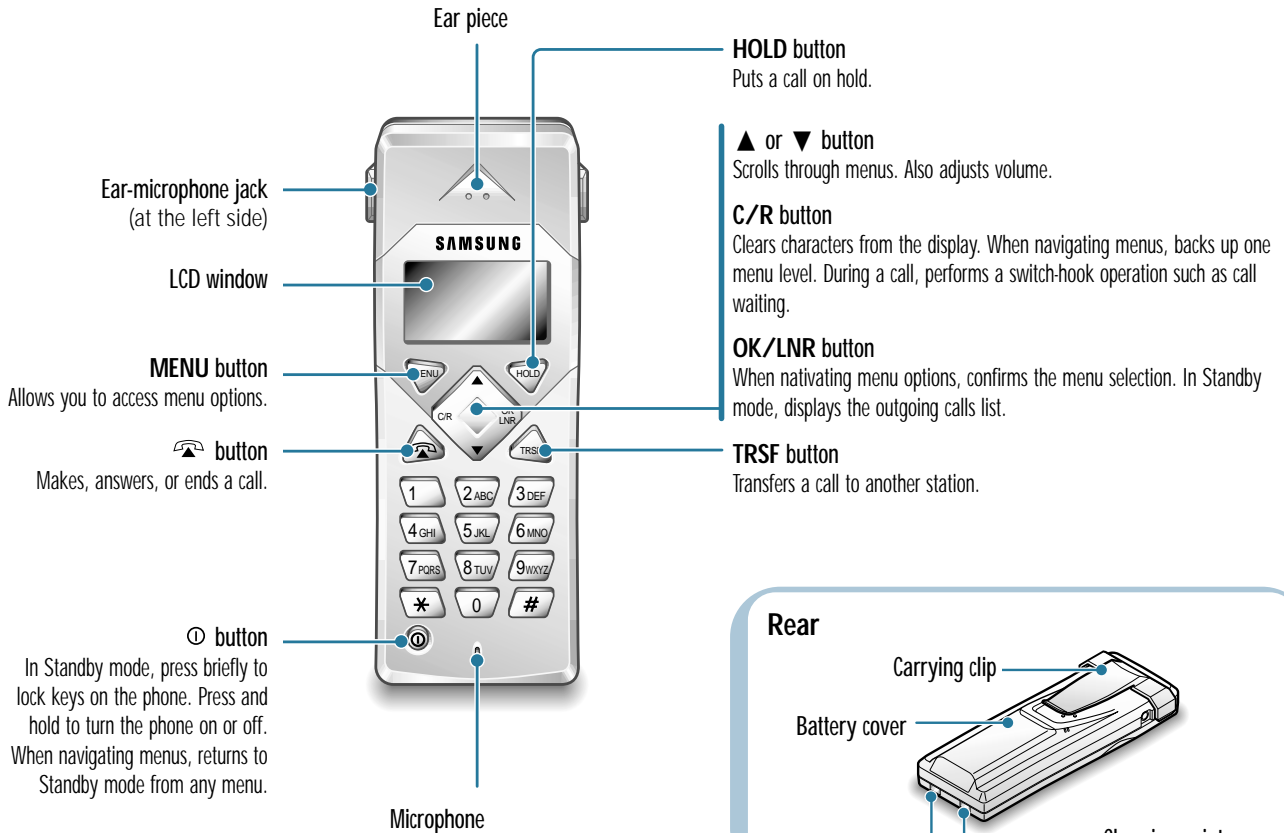

## Rear

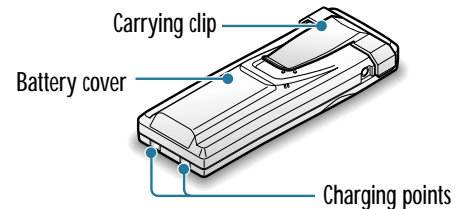

## LCD Window Icon Descriptions

1234 SAMSUNG  
08/25 FRI 10:12A

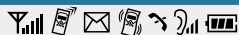

This area displays in-use information such as the other party's number, the call timer, menus, etc. In Standby mode, it displays the handset name, the current time and date.



### Signal strength icon

This icon is always displayed when your phone is on, and shows the current signal strength. More lines indicate more signal strength.



### Line icon

This icon indicates that line is engaged.



### Message icon

This icon indicates that you have message(s) waiting. The message(s) can be a voicemail notification, page, or unanswered caller's number.



### Vibrate icon

This icon indicates that an incoming call will vibrate the phone rather than ring it.



### DND icon

This icon indicates that DND function is enabled.



### Voice volume icon

This icon indicates the current voice volume level. The more bars you see, the louder the volume is.



### Battery status icon

This icon is always displayed when your phone is on, and shows the level of your battery charge. The more bars you see, the greater the charge.

## Connecting Power Adapter

1. Connect the modular end of the power adapter to the power jack of the charger, then the other end to a standard AC wall outlet.

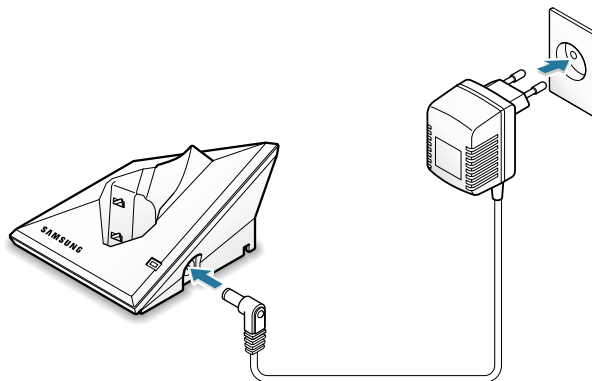

2. Route the cord through the recessed channel as shown.

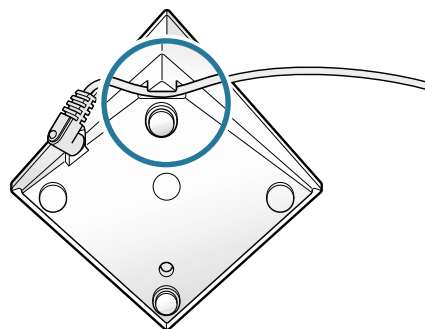

## Installing Batteries

The two AA size rechargeable Ni-MH batteries come with your phone. Install the batteries before using your phone.

1. Slide the battery cover in the direction of the arrow, then take it out.

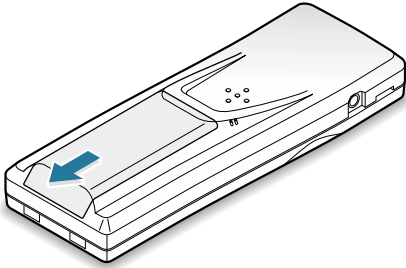

2. Remove old batteries if any, then insert new batteries observing correct polarity (+, -). Reversing the orientation may damage the handset.

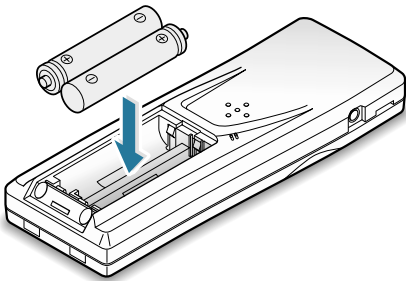

3. To replace the battery cover, slide the cover up until it snaps shut.

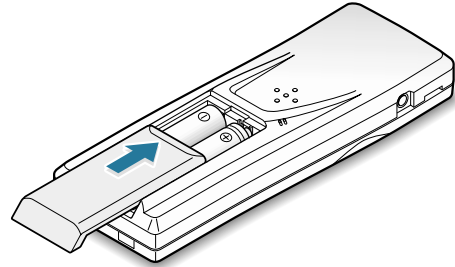

### Notes:

- The batteries need to be replaced if they do not recover their full storage capacity after recharging.
- When replacing batteries, always use good quality Ni-MH rechargeable AA size batteries. For details, see 'Specifications' on page 56. Never use other batteries or conventional alkaline batteries.

## Charging the Handset

Before initial operation, you should fully charge the handset for more than 10 hours.

To charge the handset, simply place it on the charger.

Result: When charging starts, the handset automatically turns on and the **Charge** lamp on the charger turns on.

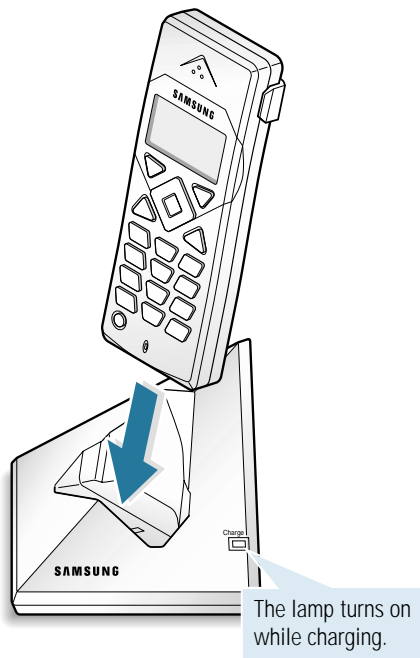

## Using the Handset Carrying Clip

The supplied handset carrying clip allows you to conveniently carry the handset with you. It clips easily to your belt, waist band, or shirt pocket.

If you want to remove the carrying clip:

Insert a phillips screw driver along the edge of one of its arms, and twist to release. Then lift it off.

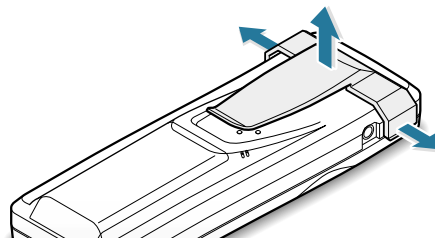

If you want to attach the carrying clip:

Attach the carrying clip to the back of the handset. Make sure that the carrying clip locks into place.

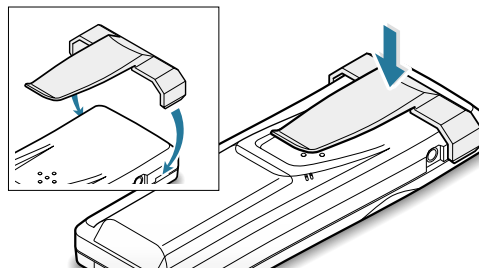

## Using the Ear-microphone (option)

With the ear-microphone, you can talk without using your hands.

Connect the ear-microphone to the jack at the top left side of the phone.

*Result:* The ear-microphone operates in the same way as the phone's speaker and microphone.

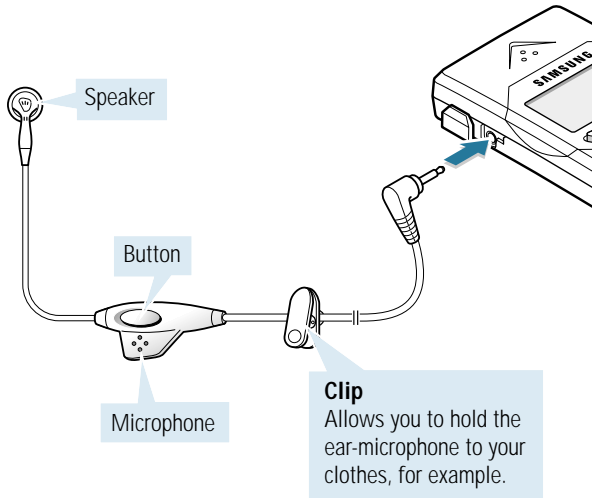

The button on the ear-microphone allows you to answer or end a call without pressing a button on the phone. If you receive a second call, press the button to end the first call and answer the second call. If you press the button in Standby mode, you can scroll through the redial list, and press and hold for more than one second to dial the number.

## Turning the Handset On/Off

When you place the handset in the charger to charge it, the handset automatically turns on. To turn the handset on or off in Standby mode, follow these steps:

1. To turn on the handset when the display is off, press **⓪** button.

*Result:* At first time your turn the phone on, the LCD window displays **UNREGISTERED**. You must register the handset to a base. See page 14.

Once the phone is registered, the phone switches to Standby mode and the display shows the handset number and **SAMSUNG** when you turn the phone on. If you change the handset name (see page 44), the display shows the customized handset name in Standby mode. The phone is now ready for use.

2. To turn the handset off, press and hold **⓪** button for about three seconds until the display turns off.

**Note:** Nothing will appear in the LCD window when battery power is very low. You should fully charge the handset before operation.



## Registering Handset

---

Register this handset to the base you will use. You can register this handset up to four different bases.

**Note:** To register a handset to a base, the handset must be within range of the base and the base should be set to the Registration mode by your system administrator.

To register a handset:

1. Press **MENU** to display main menu items.
2. Press ▼ (or ▲) button repeatedly to choose **5:System**, then press **OK** button.
3. Enter the PIN code, then press **OK** button.  
  
**Note:** PIN is preset to 0000 at factory. You can change the PIN. For details, see page 51.
4. Press ▼ button to choose **2: Register**, then press **OK** button.
5. Press ▼ (or ▲) button repeatedly to choose the base number you want to specify for the base.

**Note:** If check symbol appears at the right side of the base number, it indicates that the base number is already registered on your handset.

6. Press **OK** button.

Result: The LCD window displays the ID of the base unit.

7. Press **OK** button.

Result: The LCD window displays **Enter AC**.

8. Enter 9234, the Authentication Code, which is preset at factory.

9. Press **OK** button.

Result: When the registration is properly completed, the LCD window displays the handset number and **SAMSUNG**.

**Note:** If you have registered the handset to several bases, and the base number you select at step 5 is already used for another base, **OVERWRITE** warning appears. If you press **OK** button, the old information is cleared and the base number will be newly used for your newly selected base. To keep old information, press and hold **C/R** button to cancel the setting, then start over again with a different base number.

## Your Phone's Mode

---

### Standby mode

Standby is the most basic state of your phone. The phone goes into Standby mode soon after you turn it on. When your phone is in Standby mode, you will see the handset number and **SAMSUNG** unless you change the handset name.



While in Standby mode, you can enter a phone number, press  button to dial it.

The Main menu is accessed when you are in Standby mode by pressing **MENU**. See "Menu Map" on page 32 for a listing of the Main menu items.

### Talk mode

You can place and answer calls only when your phone is powered on. During a call, the phone is in Talk mode. While you are in Talk mode, pressing **MENU** gives you a list of options referred to as "In-use menu" on page 30.

## Making a Call

---

1. Pick up the handset and press  button.

*Result:* You hear a dial tone.

2. Dial the desired number by using the number keypad.

**Note:** You can store telephone numbers into one-digit memory cells (01-30) and dial the numbers using the assigned memory cell number. Refer to 'Phonebook' on page 36.

3. When the other person answers, speak.

4. To end the call, either press  button or replace the handset on the charger.

#### Notes:

- The LCD window displays the call time. For details, see 'Call Time Display' on page 46.
- To make a call to the last number you dialed, use the 'Redial' feature. For details, refer to 'Last Number Redial' on page 23.

## Receiving a Call

You can enter the desired phone number in Standby mode, and then dial the number. This way of dialing allows you to make corrections to the number before dialing. Follow these steps:

1. Enter a telephone number. Check the number in the LCD window.

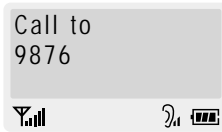



### Notes:

- If you make a mistake while entering a number, press **C/R** button to clear the last digit and correct the number.
- If you press and hold **C/R** button for more than one second, all digits you have entered are cleared and the phone returns to the Standby mode.

2. When the number appears correctly, press  button.

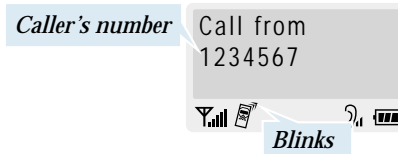
When somebody calls you, the phone rings and the  icon on the display blinks.





If the caller can be identified, the caller's phone number is displayed. If the caller cannot be identified, only the  icon blinks.

1. To answer the call, press  button. Or

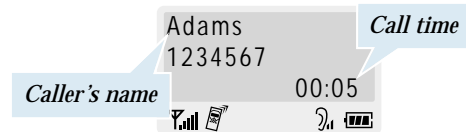
If the handset is on the charger, simply lift it up. You do not need to press  button.



Result: You are connected and the  icon is steadily on. The LCD window displays the call time. If the caller name is currently stored in your internal phonebook, the caller name displays.

2. You can speak. To end the call, either press  button or replace the handset on the charger.

**Note:**  button does not work for 3 seconds to prevent the phone from being disengaged, right after you lift the phone from the charger to receive the call.

## Out of Range Indication

If the handset is too far from the registered base, the handset cannot properly engage the telephone line, and the  icon at the left bottom of the LCD window blinks and the signal strength indication bars next to the  icon disappear.



*This icon blinks when the handset is out of range.*



RANGE OUT  
08/25 FRI 10:30A  
 

If you move out of range during a call, the telephone line might be disconnected and the handset returns to Standby mode. Check if the  icon blinks in the LCD window. If so, move the handset closer to the charger.

## Battery Level Indicator

The  icon is continuously displayed at the right bottom of the LCD window. The  icon shows the level of your battery. The more bars you see, the more power you have left.





1234 SAMSUNG  
08/25 FRI 10:30A  
       
*Full* *Flat*





When the battery is weak and a few minutes of talk time remain, you will hear a warning tone and the  icon blinks.

When the battery becomes too weak for the phone to operate, the handset will automatically turn off. Place the handset on the charger to charge the handset batteries.

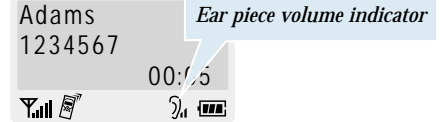
## Adjusting Voice Volume





During calls,  or  button affects the ear piece volume. You can adjust the volume from level 1 to 3. The voice volume is displayed as bars on the bottom line of the LCD window. The more bars you see, the louder the volume is.





Adams  
1234567  
00:15  
     
*Ear piece volume indicator*

## Selecting Ring Type

You can define your own ringing sound. Six ring types are available.

1. Press **MENU** to display main menu items.
2. Press  (or ) button repeatedly to choose **4: Bell&Beep**, then press **OK** button.
3. Press  button to choose **2: RingType**, then press **OK** button.
4. Press  (or ) button repeatedly to choose the ring type you want.

*Result:* Each time you press  or  button, the handset sounds the ring you have chosen.

5. Press **OK** button to save the setting, then press  to return to Standby mode.

## Adjusting Ring Volume

---

1. Press **MENU** to display main menu items.
2. Press ▼ (or ▲ ) button repeatedly to choose **4: Bell&Beep**, then press **OK** button.
3. Press ▼ (or ▲ ) button repeatedly to choose **3: RingVol**, then press **OK** button.

*Result:* The current ring level is displayed.

4. Press ▼ (or ▲ ) button repeatedly to choose the volume level you want.

*Result:* You can adjust the volume from level 1 to 3. The higher, the louder. You can also turn the ringer **OFF**. Each time you press ▲ or ▼ button, the handset sounds its selected loudness.

5. Press **OK** button to save the setting, then press  to return to Standby mode.

**Note:** Setting “**OFF**” turns the ringer off. When a call comes in, only the  icon on the window blinks.

## Last Number Redial

---

Your phone allows you to call the most recently dialed numbers again. The phone stores the last 10 numbers you called.



To view and dial the numbers:

1. Press **LNR** button in Standby mode.

*Result:* The LCD window displays the last number you dialed.

2. If you want to scroll through the memory, press ▼ or ▲ button until you find the desired number you want to call.
3. Press  button to dial the number.

### Notes:

- If there is no number dialed, **Empty** is displayed.
- Each time you dial a new number, the oldest number stored in the redial memory is automatically erased, and the redial memory is updated.
- You can modify the number displayed before pressing  button by using **C/R** button.
- If you press **LNR** button, followed by  button, the phone dials the last number immediately.
- To erase all numbers in Redial memory, reset the handset. If you reset the handset, all numbers stored in Redial memory are erased. See page 52.

## Fuzzy Dialing

---

This dialing option allows you to enter the first digit of someone's phone number, then have your phone remember the rest of the number, and dial it for you.

To use this dialing option, the number you want to call must be already stored in the internal phonebook, incoming or outgoing call logs, and the fuzzy dial option must be enabled using the **Setting** menu.

To enable fuzzy dial feature:

1. Press **MENU** to display main menu items.
2. Press ▼ (or ▲) button repeatedly to choose **3: Setting**, then press **OK** button.
3. Press ▼ (or ▲) button repeatedly to choose **4: FuzzyDial**, then press **OK** button.

*Result:* The current setting is displayed.

4. Press ▼ (or ▲) button repeatedly to choose **ON** or **OFF**. To enable this feature, select **ON**.
5. Press **OK** button to save the setting, then press  to return to Standby mode.

To place a call using fuzzy dial feature:

1. In **Standby mode**, press the first digit of the desired phone number.

*Result:* The phone searches for the phone number beginning with the specified number from the internal Phonebook or Call logs, then displays the first number.

2. Press ▼ or ▲ button to scroll through the numbers beginning with the number you entered.
3. Press  button to dial the number displayed. Or press **C/R** button to exit this fuzzy dial mode.

## Putting a Call on Hold

---

You can place a current call on hold whenever you want.

To place a call, press **HOLD** button during a call.

*Result:* The display shows **On Hold**.

To retrieve the call placed on hold, press **HOLD** button again.

*Result:* You can continue conversing with the other party.

## Transferring a Call

---

This feature allows you to transfer a call to another intercom station. Any outside or intercom call may be transferred, regardless of whether you initiated the call or the call rang in to you.

When you transfer a call, you may wait on the line until the transferred station answers, or you may hang up when you hear the ringback tone. The connection between the caller and the person to whom the call is being transferred is completed when you hang up.

1. With intercom or outside call in progress, press **TRSF** button.

*Result:* The call is automatically put on hold. The LCD window displays **Transfer to**.

2. Dial the extension number that you want to transfer the call.

3. Replace the handset.

Or, wait on the line and speak with the station about the call transfer, then replace the handset.

**Note:** If the transferred station is busy, press **TRSF** button again. You will be reconnected to the original call.

## Setting Up a Conference

---

You may confer with up to five parties over the phone in any combination of outside lines and intercom stations in any order.

To setup a conference:

1. Make a call to the first party.
2. When she (or he) is connected, press **MENU** button, and select **Conference** from the in-use menu options.

*Result:* The LCD window displays **Make next Call**.

3. Make another call to another party.
4. When the party answers you, repeat steps 2 and 3 until all parties are added.
5. To begin conference, press **MENU** twice.



*Result:* The LCD window displays the parties who joined the conference.

## Key Lock

---

If you turn this feature on, all buttons except for  button will be locked and not operate at all.

When a call comes in, you can answer calls by using  button. But when you finish the call, the phone returns to the lock mode. This feature is useful to avoid accidental key pressing.

1. To turn the feature on, press  button briefly until **KEY LOCK** displays in the LCD window.
2. To turn the feature off, press  button briefly until **KEY LOCK** disappears in the LCD window.

### Notes:

- If a power failure occurs, the 'Key Lock' feature is automatically canceled.
- Do not hold  button for more than three seconds, or the handset will turn off.

## Registered Recall

---

The **C/R** button is used in conjunction with special services such as 'Call waiting' which may be offered by your telephone company. You can place a new call directly after a call or transfer a call to another extension under PABX, using this feature.

To send a flash, simply press **C/R** button while the line is engaged.

Result: The display shows **F**.



Your phone includes both a Main menu and an In-use menu:

- Main menu – The main menu in Standby mode contains seven primary options, all of which contains sub menus (see “Menu Map” on page 32).
- In-use menu – The In-use menu options are available in Talk mode. You can choose from:
  - 1:Msg wait (see page 33)
  - 2:DND (see page 54)
  - 3:Conference Call (see page 27)

## Menu Navigation

---

There are two ways to set a menu option on your phone:

- You can scan all menu options available, then select the option you want.
- If you know the number of the option you want to select, you can just use the number to quickly access the menu option.

To access a menu option using the scroll buttons:

1. To display menu items, press **MENU** button.
2. To scan menu options, press ▼ or ▲ button repeatedly.
3. To select a desired option, press **OK** button when the number of the option you want blinks.
4. Repeat as necessary.

To access a menu option using the option number:

1. To display menu items, press **MENU** button.
2. Press the associated number key to select the desired option (You do not have to scroll through the list or display an option in order to select it).

To return to Standby mode from any menu:

If you press **C/R** button from any menu (not in number or text input mode), the phone backs up one menu level.

Pressing  button will return you to Standby mode from any menu. Also, the phone will automatically return to Standby mode from any menu if you do not touch a button for about ??? seconds.

## Menu Map

The following illustration shows the menu structure available and indicates:

- Number assigned to each option
- Brief description and the page on which you can find details of each feature.

1. Call Log (see page 35.)
2. Phonebook
  - 1: Search (see page 41.)
  - 2: Edit (see page 36.)
3. Setting
  - 1: HS Name (see page 44.)
  - 2: Language (see page 45.)
  - 3: CallTime (see page 46.)
  - 4: FuzzyDial (see page 24.)
  - 5: PrefixEdit (see page 47.)
4. Bell&Beep
  - 1: KeyTone (see page 48.)
  - 2: RingType (see page 21.)
  - 3: RingVol (see page 22.)
  - 4: Alert Type (see page 49.)
  - 5: UniRing (see page 50.)
5. System
  - 1: PinChange (see page 51.)
  - 2: Register (see page 14.)
  - 3: FuncClear (see page 52.)
6. Select Base (see page 53.)
7. DND (see page 54.)

## Call Log

### Call Log

Your phone receives three kinds of messages: voicemail notification (VMN) messages, page messages, and unanswered caller's phone numbers (if the caller can be identified). When your phone receives a message, the LCD window displays the number of the received messages and  icon remains on the screen until you read the caller's numbers or delete the page or VMN messages waited on your station after you listen or read them.

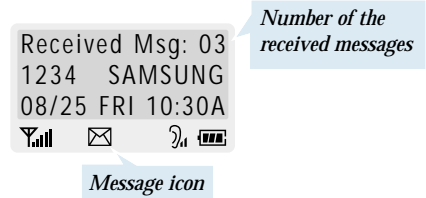

Your phone stores up to 10 messages in the phone's call log.

To review messages:

1. Press **MENU** to display the main menu items.
2. Press **OK** button to access **1: Call Log** menu.

*Result:* The LCD window shows the last message, and the date and time when the call was received if the information has been transmitted from the network. If there is no message received, **Calllog data is empty** is displayed.

3. Scroll through the memory and choose the message you want to listen, or read by using ▲ or ▼ button.

Result: For caller's number, the caller's number (and name if stored in your internal phonebook) displays.

For page message, <<MSG>> displays at the top line of the display.

For voicemail, the voicemail access number displays.

4. When a phone number displays, pressing  button dials the number.

**Note:** The last message is stored in the memory cell '0'. When a new call is received, the previous message is shifted to the next cell '1', allowing the new message to be stored in this position. The oldest message is automatically erased.

## To Erase a Number Received

You can erase external or intercom station number stored in your call logs. The  icon remains on the screen unless you delete the page message.

1. When the call log data you want to erase displays, press **OK** button.
2. Press ▲ or ▼ button to choose **2: Delete** from the options.
3. Press **OK** button to confirm the deletion.

Result: You hear a confirmation beep and the phone returns to the Standby mode.

## To Save a Number into Phonebook

1. When you are viewing a phone number stored in the call log, press **OK** button.
2. Press **OK** button to access **1: Save to Pb** option.
3. Enter name, and specify the memory cell. For details, see page 36.

The internal Phonebook allows you to store frequently used phone numbers and their associated names in your personal directory so that you can easily make a call without having to remember or enter the phone number. You can store up to 30 numbers.

## Storing a Phone Number with a Name

---

1. Press **MENU** to display main menu items.
2. Press **▼** button to choose **2: Phonebook**, then press **OK** button.
3. Press **▼** button to choose **2: Edit**, then press **OK** button.
4. Enter the desired number (up to 24 digits), then press **OK** button.

**Note:** If you make a mistake while entering a number at this step or name at the next step, use **C/R** button to correct the mistake. Each time you press the button, the last digit is cleared. To clear all digits, press and hold the **C/R** button. Then enter the correct number.

5. Enter the name (up to 12 digits) for the number, then press **OK** button. Refer to “Entering a Name” on the following page.
6. The first available cell to save the number appears. If you want to find another memory cell, press **▲** or **▼** button, or enter the desired cell number.
7. Press **OK** button to save the setting.

**Note:** If you select the memory cell under which a number has already been stored, you are asked to replace the cell with the newly entered number. If you are, press **OK** button. If not, press **C/R** button.

## Entering a Name

1. Press the key labeled with the required letter:

- Once for the first letter
- Twice for the selected letter
- And so on

List of characters are shown below:

Key	Characters in the order displayed
0	0 , : ; ' " / = - + ( ) < >
1	Space 1 ! ? & @ _ \$ ¥ §
2	A B C a b c 2 Ä Å Æ Ç à ä å æ
3	D E F d e f 3 É Δ Φ è é
4	G H I g h i 4 Θ Ψ ì
5	J K L j k l 5 Λ
6	M N m n o 6 Ñ Ò ñ ø ò ö
7	P Q R S p q r s 7 Π Σ Ξ β
8	T U V t u v 8 Ü ü ü
9	W X Y Z w x y z 9 Ω

2. Select the other letters in the same way. The cursor moves to the right when you press a different button.

**Note:** When entering the same letter twice (or a different letter on the same button), just wait for a few seconds for the cursor to move automatically, and then select the next letter. You can move the cursor to the right by using the ▼ button. To delete letters, use the **C/R** button.

## Using a Pause

A pause is useful when you access an interactive voice response system, such as an automated banking system. A pause delays for about 3 seconds.

If you want to insert a dialing pause between numbers when you store a number in memory, press and hold **OK** button until – appears at the pause entry.

## Dialing a Number in Phonebook

---

Once you have stored phone numbers in the internal Phonebook, you can dial them easily whenever you want.

### One-touch dialing

Memory cells from 01 through 09 are special one-touch memory cells. You can dial the phone numbers stored in the cells from 01 through 09 simply by pressing one button.

In Standby mode, press and hold the second digit of the memory cell containing the number to be dialed.

*For example:* Memory cell number 09  
Press **9** and hold. The number stored is displayed, then dialed.

### Two-touch dialing

In Standby mode, press the first digit briefly, then hold down the second digit of the memory cell.

*For example:* Memory cell number 23  
Press **2** briefly and hold down **3**. The number stored is displayed, then dialed.

## Searching for Numbers in Phonebook

---

If you do not remember which telephone numbers have been stored in the various memory cells, you can scan through the memory until you find the one you are looking for.

1. Press **MENU** to display main menu items.
2. Press **▼** button to choose **2: Phonebook**, then press **OK** button.
3. Press **OK** button to access **1: Search** menu.
4. Enter the memory cell number, then press **OK** button.  
  
*Result:* The display shows the phone number stored under the selected cell.  
  
**Note:** If you press **OK** button without entering a cell number, the display shows the first cell containing phone number.
5. Press **▼** (or **▲**) button to scroll through the stored entries.
6. You can place a call by pressing  button when you find the number you want to call.

## Erasing Numbers from the Phonebook

---

To erase an entry in the internal Phonebook:

1. Find the Phonebook entry that you want to erase. Refer to “Searching for Numbers in Memory” on page 41.
2. Press **OK** button to display Phonebook option menus.
3. Press **▼** button to choose **2: Delete**, then press **OK** button.

*Result:* Your phone will prompt you for confirmation.

4. Press **OK** button to confirm, or press **C/R** button to cancel the deletion.

*Result:* You will hear a confirmation beep and the phone returns to Standby mode.

To erase all numbers in the internal Phonebook:

If you reset the phone, all numbers stored in the internal Phonebook are erased. Refer to “Reset” on page 52.

## Changing Your Internal Phonebook

---

1. Find the Phonebook entry that you want to change. Refer to “Searching for Numbers in Memory” on page 41.
2. Press **OK** button to display Phonebook option menus.
3. Press **OK** button to access **1: Modify** option.
4. Change the number or name as described on page 36 steps 4 and 5.

*Result:* You will hear a confirmation beep.

5. To exit, press .

# Setting

Many different features of your phone can be customized to suit your preferences. All of these features are accessed via **Setting** menu.

## Setting Handset Name

---

This option allows you to set your handset name. The handset name displays in Standby mode.

1. Press **MENU** to display main menu items.
2. Press ▼ (or ▲) button repeatedly to choose **3: Setting**, then press **OK** button.
3. Press **OK** button to access **1: HS Name** option.

*Result:* The cursor is blinking. If you have already registered a handset name, the name is displayed.

4. Enter your personal handset name by pressing the alphanumeric keys on the number keypad, then press **OK** button.

*Result:* A maximum of 16 digits can be entered. For details on entering a name, see page 38. If necessary, use **C/R** button to erase the current greeting message.

5. To return to Standby mode, press .

**Note:** If you want to restore the greeting message to the default setting, erase the user-defined message.

## Selecting Language

---

You can select a display language. 3 different languages are available. This feature is preset to English at factory.

1. Press **MENU** to display main menu items.
2. Press ▼ (or ▲) button repeatedly to choose **3: Setting**, then press **OK** button.
3. Press ▼ button to choose **2: Language**, then press **OK** button.

*Result:* The current setting displays.

4. Press ▼ (or ▲) button repeatedly to choose the desired language.
5. Press **OK** button to save the setting.

*Result:* A long confirmation beep sounds.

6. To return to Standby mode, press  button.



## Setting Call Time Display

---

If you turn the feature on, the handset automatically times the duration of calls. The handset displays the call duration both during your call and also for a few seconds after your call is completed. The feature is preset to **ON**.

1. Press **MENU** to display main menu items.
  2. Press ▼ (or ▲) button repeatedly to choose **3: Setting**, then press **OK** button.
  3. Press ▼ (or ▲) button repeatedly to choose **3: CallTime**, then press **OK** button.
- Result:* The display shows the current setting.
4. Press ▼ (or ▲) button to choose **ON** or **OFF**. Select **ON** to turn this feature on.
  5. Press **OK** button to save the setting.

6. To return to Standby mode, press .

## Editing Prefix Number

---

Prefix number option allows you to add digits such as outside line access number '9' to an external phone number currently stored in your Call logs. When you dial the external phone number stored in Call logs, the prefix number is automatically dialed before the phone number.

The prefix number is preset to '9' at factory.

To change the prefix number:

1. Press **MENU** to display main menu items.
2. Press ▼ (or ▲) button repeatedly to choose **3: Setting**, then press **OK** button.
3. Press ▼ (or ▲) button repeatedly to choose **5: PrefixEdit**, then press **OK** button.

*Result:* The display shows the current setting.

4. Enter the desired prefix number.

**Note:** You enter up to 4 digits.

5. Press **OK** button to save the setting. Then press  to return to Standby mode.

# Bell & Beep

You can use the **Bell&Beep** menu to customize various sound settings.

## Setting Key Tone

---

You can set your handset not to sound the key tone each time you press a key.

1. Press **MENU** to display main menu items.
2. Press ▼ (or ▲) button repeatedly to choose **4: Bell&Beep**, then press **OK** button.

3. Press **OK** button to access **1: KeyTone** option.

*Result:* The display shows the current setting.

4. Press ▼ (or ▲) button repeatedly to scroll through the key tone options.

*Result:* You can choose from:

- TYPE 1 – Standard key tone.
- TYPE 2 – Two-frequency tone.
- OFF – The key tone does not sound.

5. Press **OK** button to save the setting. Then press  to return to Standby mode.

## Selecting Ring or Vibrator

---

This option allows you to indicate how you are to be alerted any incoming calls. The following options are available:

- **RING:** The phone rings using the ring tone selected via the **Ring Type** menu option.
- **VIBRATOR:** The phone vibrates but does not ring.
- **RING + VIBRAT:** The phone rings first, then vibrates.

1. Press **MENU** to display main menu items.
2. Press ▼ (or ▲) button repeatedly to choose **4: Bell&Beep**, then press **OK** button.
3. Press ▼ (or ▲) button repeatedly to choose **4: AlertType**, then press **OK** button.
4. Press ▼ (or ▲) button to scroll through the alert types.
5. When the desired alert type displays, press **OK** button to save the setting.
6. To return to Standby mode, press .

## Setting Unique Ring

---

This option allows you to designate a unique ring to signal an incoming call from a specified call number. You can use this feature only when the caller's service network transmits the caller's information.

You can specify 2 callers and select a unique ring tone for each caller from 6 different tones.

1. Press **MENU** to display main menu items.
2. Press ▼ (or ▲) button repeatedly to choose **4: Bell&Beep**, then press **OK** button.
3. Press ▼ (or ▲) button repeatedly to choose **5: UniRing**, then press **OK** button.
4. Press ▼ (or ▲) button to choose the ring address you want, then press **OK** button.
5. Enter the phone number you want to designate, then press **OK** button.
6. Press ▼ (or ▲) button to scan through the ring types available, then press **OK** button to save the setting.
7. To return to Standby mode, press .

## System

PIN (Personal Identification Number) is required to access **System** menu.

### Changing PIN

---

The PIN is required when you register handset to a base unit and use **System** menu. The PIN is preset to '0000' at factory.

To change the PIN code:

1. Press **MENU** to display main menu items.
2. Press ▼ (or ▲) button repeatedly to choose **5: System**, then press **OK** button.
3. Enter the current PIN code to access the **System** menu, then press **OK** button.  
  
*Result:* The LCD window dose not display the PIN code you entered in order to maintain secrecy.
4. Press **OK** button to access **1: PinChange** option.

**Note:** If you enter a wrong PIN code, your phone returns to Standby mode.

5. Enter the new PIN code again to confirm the number, then press **OK** button.

**Note:** If you change the PIN code and then forget it, enter the default PIN "0000."

6. To return to Standby mode, press  button.

## Reset

---

If you reset the handset, all the user-selectable features return to the manufacturer's default status.

1. Press **MENU** to display main menu items.
2. Press ▼ (or ▲) button repeatedly to choose **5: System**, then press **OK** button.
3. Enter the PIN code to access the **System** menu, then press **OK** button.
4. Press ▼ (or ▲) button repeatedly to choose **3: FuncClear**, then press **OK** button.
5. Press **OK** button to confirm the selection. Then press  to return to Standby mode.

## Selecting Base

---

Your handset can be used with up to four base units. This menu option allows you to select the base you want to use.

**Note:** To use the handset with more than one base unit, you must register the handset at each base unit. See page 14.

To select a base unit:

1. Press **MENU** to display main menu items.
2. Press ▼ (or ▲) button repeatedly to choose **6: Select Base**, then press **OK** button.
3. Press ▼ (or ▲) button repeatedly to scroll through the available bases.

*Result:* If you choose **Best Base**, when you are moving around and lose contact with the base unit, the handset will automatically find the first available base unit.

4. Press **OK** button to save the setting. Then press  to return to Standby mode.

## Do Not Disturb

When you do not want to be disturbed with any incoming calls, this feature allows you to block incoming calls temporarily. You can still make and receive calls. You can set up this feature in Standby mode or Talk mode.

To activate (or cancel) this feature:

1. Press **MENU** in Standby mode or in Talk mode.
2. Press ▼ (or ▲) repeatedly to choose **7: DND** in Standby mode (or **2: DND** in Talk mode), then press **OK** button.
3. Press ▼ (or ▲) to choose **ON**. To cancel this feature, choose **OFF**.
4. Press **OK** button to save the settings. Then press  to return to Standby mode.

Result: With this feature on, the LCD window displays **Do Not Disturb** to remind you of the mode and  icon appears.

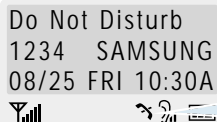

Do Not Disturb  
1234 SAMSUNG  
08/25 FRI 10:30A

 **DND icon**

## Troubleshooting

Symptom	Check
No operation	<ul style="list-style-type: none"><li>• Check that the power adapter is properly connected.</li><li>• Check that the handset is properly registered on the base.</li><li>• Check that the handset is within range of the base unit.</li><li>• Check that the handset is fully charged.</li><li>• Check that the handset batteries are installed properly.</li></ul>
No dial tone	<ul style="list-style-type: none"><li>• Check that the handset is properly registered on the base.</li><li>• Check that the handset is within range of the base unit.</li><li>• Check that the power adapter is properly connected.</li></ul>
Warning beep occurs when making a call.	<ul style="list-style-type: none"><li>• Check that the handset is not too far from the base.</li><li>• Check that the handset batteries are not in low status.</li></ul>
The handset seems to have very short battery life.	<ul style="list-style-type: none"><li>• Clean the charging points.</li><li>• Consistently short battery life may indicate that replacement of the batteries is necessary.</li></ul>

## Specifications

---

Frequency Range	1.88-1.90 GHz
Channels	120 Duplex channels
Carrier Power	≤ 250 mW (24 dBm)
Modulation	GFSK
Frequency Stability	≤ ± 50 kHz
Operation Time	Ni-MH: Standby mode: 130 hours Talk mode: 12 hours
Charging time	10 hours
Ambient temperature	Normal : 15 °C ~ 35 °C Extreme: -10 °C ~ 40 °C
Humidity	5 % ~ 90 %
Weight	Handset: 100 g with carrying clip Charger: 92 g
Dimensions	Handset: 120 x 45 x 22 mm (HWD) Charger: 118 x 118 x 53 mm (HWD)
Power Supply	Handset Input: Ni-MH: 2.4 V, 550 mA Charger Input: DC 9 V, 150 mA
Compliance	CTR 06 CTR 10 CTR 22 EMC NET4 (PSTN)